

Pioneer

AVIC-F500BT

**ADVANCED MULTIMEDIA
NAVIGATION SYSTEM**

Hardware User Manual

R00

Trademarks

The Bluetooth word mark and logo are owned by the Bluetooth SIG, Inc. All other brand and product names are trademarks or registered trademarks of their respective companies.

Note

The information in this document is subject to change without notice.



Table of Contents

Notice	ii
1 Getting Started	3
1.1 Understanding Hardware Features	3
Front Components	3
Back Components	4
Right-Side Components	5
Left-Side Components	5
1.2 Installing the Battery	6
1.3 Connecting to AC Power and Charging the Battery	7
1.4 Using Your Device in a Vehicle	8
Connections	8
Using the Device Cradle	9
Connecting the Car Charger	10
1.5 Turning Your Device On and Off	11
1.6 Navigating on the Screen	11
1.7 Using a SD Card	12
2 Troubleshooting and Maintenance	13
2.1 Resetting Your System	13
Hard Reset	14
2.2 Troubleshooting	15
Power Problems	15
Screen Problems	15
GPS Problems	15
2.3 Maintaining Your Device	17



Notice

- Before using this product, read “Important Information for the User” (a separate manual) which contains warnings, cautions, and other important information that you have to follow.
- This manual provides only the hardware information. For information on the GPS navigation software and other software operations, see the “Software Operation Manual.”

1

Getting Started

1.1 Understanding Hardware Features

Front Components



Ref	Component	Description
1	Menu Button	Press to open the Main Menu .
2	Map Button	Press to open the Map Menu .
3	Scroll Wheel	Rotate to adjust the volume.
4	Control Button	Map zoom in and zoom out by pressing up and down. Audio track up and down by pressing left and right. Activate the Bluetooth function by pressing the center.
5	Microphone	For Bluetooth hands-free calling.
6	Power Button	Turns the device on and off by pressing for at least 2 seconds. (See sections 1.5 for more information on the Power Button functions).
7	Bluetooth Indicator	Flashes (Blue) to indicate that the Bluetooth is in searching and pairing mode.

Glows in blue when connected to a Bluetooth device.

- 8 Touch Screen** Displays the output of your device. Touch the screen with your fingertip to select menu commands or enter information.
-

Back Components

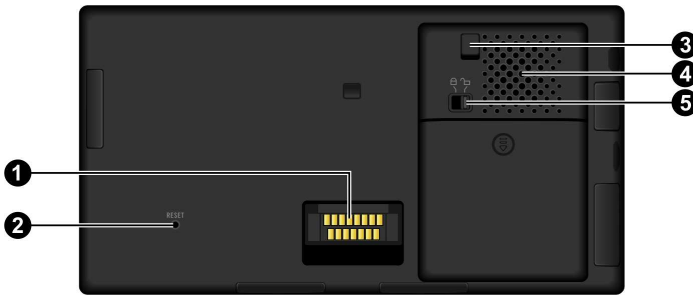

Ref	Component	Description
1	Cradle Connector	Connects to the cradle. (The cradle supplied with your device depends on the country/region you are in.)
2	Reset Button	Restarts your device (soft reset).
3	External GPS Antenna connector	This connector (under rubber dust cover) allows the use of an external GPS antenna which may be positioned on top of the vehicle for better signal reception in areas with poor reception. (Contact Pioneer Support Center for recommendations on available third party products.)
4	Speaker	For voice prompts, system operation tones, and hands free telephone calls.
5	Battery Lock	Lock or unlock the battery cover.

Right-Side Components

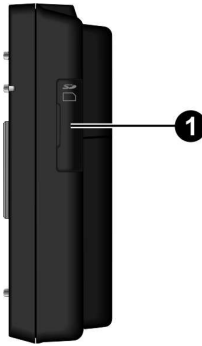

Ref	Component	Description
1	SD slot	Accepts an SD (Secure Digital) card for data and future software updates.

Left-Side Components

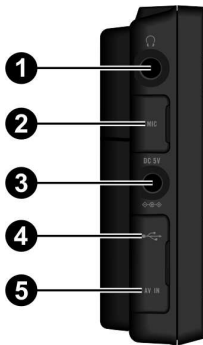

Ref	Component	Description
1	Headphone Connector	Connects to stereo headphones.
2	Microphone Connector	Connects to an external microphone (under rubber dust cover).
3	Power Connector	Connects to the AC adapter.

Ref	Component	Description
④	Mini-USB Connector	Connects to the mini-USB cable for iPod or the convertible cable for USB device (under rubber dust cover).
⑤	AV IN Connector	Connects to AV jack for iPod or an external video source (under rubber dust cover).

1.2 Installing the Battery

1. Make sure that the device is not turned on or connected to the AC power.
2. Slide the battery lock to the unlock (🔓) position (①).
3. Slide the battery cover downward and remove the cover from the battery compartment (②).

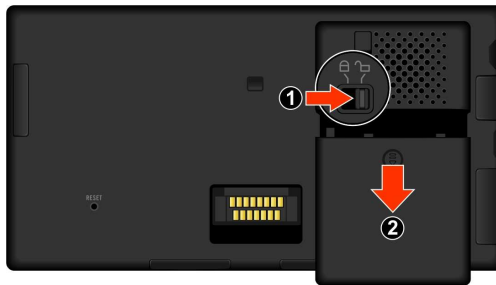

4. Insert the battery pack (provided with your device) into the right side of the compartment first, and then press down until you hear it “Click”.

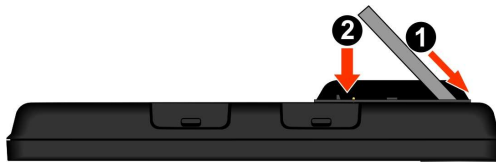

5. Replace the battery cover and slide the battery lock back to the lock (🔒) position.

| NOTE: To remove the battery, see section 2.1 for more information.

1.3 Connecting to AC Power and Charging the Battery

Please fully charge your device before using it the first time.

1. Connect the AC adapter to the power connector on your device (❶).
2. Connect one end of the power cable to the AC adapter (❷) and the other end to a wall outlet (❸).

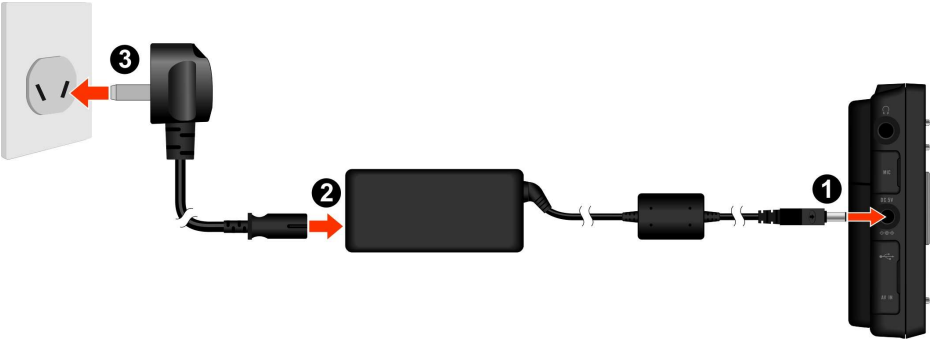

Do not disconnect your device from AC power until the battery is fully charged. It may take several hours to fully charge.

CAUTION: For optimal performance of the lithium battery, take note of the following:

- Do not charge the battery where the temperature is high (e.g. in direct sunlight).
- Unlike other rechargeable batteries, there is no need to fully discharge the lithium battery before recharging.
- If you will not use the product for a long period of time, be sure to fully recharge the battery at least once every two weeks. Over discharge of the lithium battery can affect the charging performance.

1.4 Using Your Device in a Vehicle

Connections

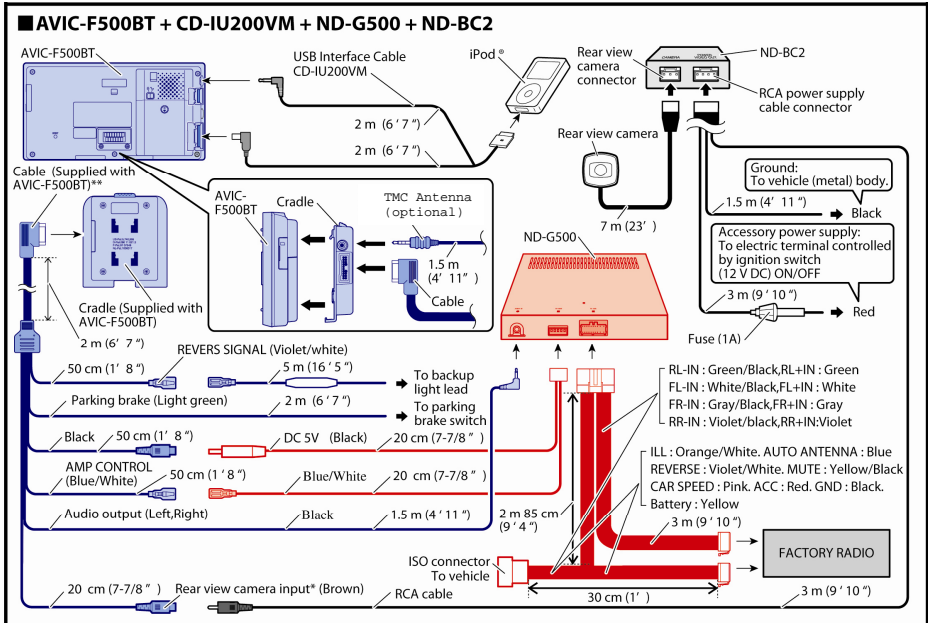

Switch an iPod's video output "ON" to view video.

Refer to page ** and ** for the supported iPod software version.

*Use input only for reverse or mirror image rear view camera. Other use may result in injury or damage.

Using the Device Cradle

NOTE:

- Depending upon the specific model available in your country/region, the device cradle supplied with your device may not look exactly the same as the picture shown.
- If the windshield of your vehicle is tinted with a reflective coating, an external antenna (optional) may be needed to route the antenna to the top of the car through a window.
- Don't leave the device in the place where it gets direct rays of the sun.

Mounting on the Windshield

Attach the device to the device cradle (1a). Then slide the cradle into the adapter end of the suction mount (1b) and lock into place by pressing down. Lastly, attach the suction side of the suction mount to your windshield, and lock by pressing the lever toward the suction cup (1c).



Mounting on the Dashboard

Attach the device to the device cradle and the adapter end of the suction mount as described above (1a and 1b). Stick the Dash Mounting Plate onto your dashboard (2a), and attach the suction side of the suction mount to the plate (2b).

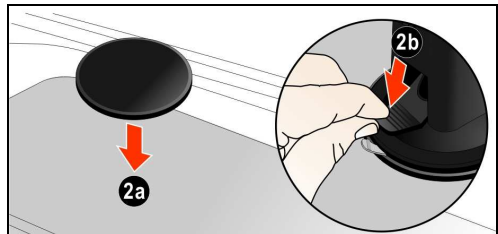

Connecting the Car Charger

The car charger supplies power to your device when you are using the device in a vehicle.

CAUTION: To protect your device against sudden surges in current, connect the car charger only after the vehicle engine has started.

1. Connect one end of the car charger directly to the power connector on your device.

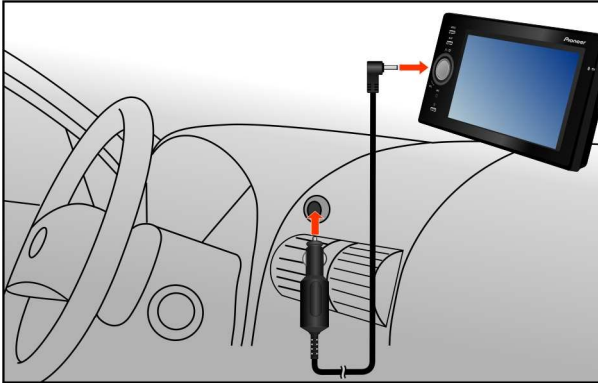

If you are using the ND-G500 (supplied with AVIC-F500BT), you need to connect to the black cradle cable. (See the “Connections” section for details.)

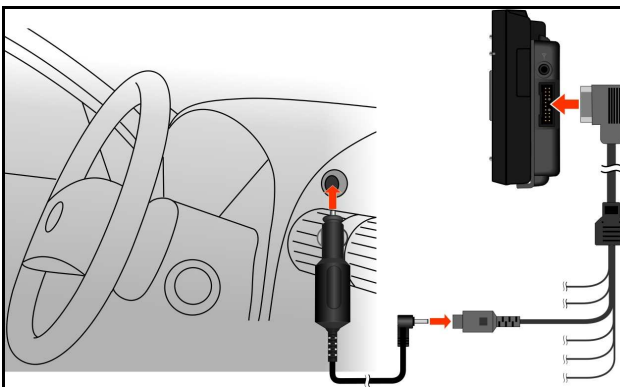

2. Connect the other end to the 12-volt cigarette lighter or power port to power and charge your device.

1.5 Turning Your Device On and Off

Press and hold the power button for at least 2 seconds to turn on and off your device.



When you press the power button to turn off the unit, your device actually enters into a suspend state and the system stops operating. Once you turn on the system again, it resumes from the same screen you left off at.

1.6 Navigating on the Screen

To navigate and select objects on the screen, simply use your finger and touch the screen. The followings are possible via touch screen:

- **Tap**
Touch the screen once with your finger to open items or select options.
- **Drag**
Hold your finger on the screen and drag up/down/left/right or across the screen.
- **Tap and hold**
Tap and hold your finger until an action is complete, or a result or menu is shown.



1.7 Using a SD Card

| NOTE: Please ensure that no foreign objects enter the card slot.

Your device features a SD slot where you can insert an optional storage card. To use a storage card, insert it into the card slot, with the connector pointing to the slot and its label facing the front of the device.



To remove a card, first make sure that no application is accessing the card, and then slightly push the top edge of the card to release it and then pull it out of the slot.

2

Troubleshooting and Maintenance

This chapter gives you solutions to some problems you may encounter. It also provides guidelines on how to care for your device.

NOTE: If you encounter a problem you cannot solve, contact Pioneer Customer Service for assistance.

2.1 Resetting Your System

Occasionally, you may need to reset your device.

Use a pointed object (avoiding sharp objects) to press the reset button on your device. This is called a “soft reset.”

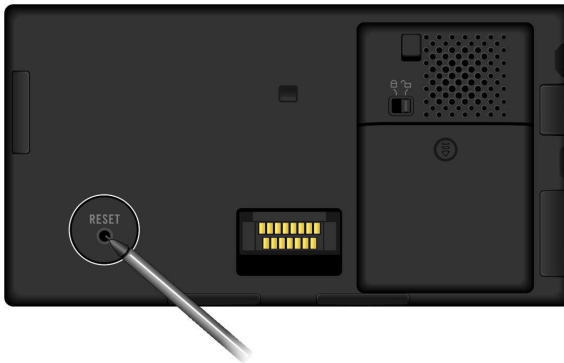

Hard Reset

If your device still does not respond after a soft reset, you can use the following steps to perform a “hard reset.”

1. Disconnect all the cables, including the AC adapter, from your device.
2. Slide the battery lock to the unlock (🔓) position and remove the battery cover. Lift the battery upward to release it from its compartment.

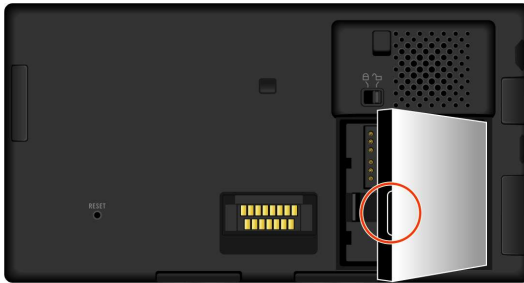

3. Wait for a few seconds. Reconnect the AC power and replace the battery back to its compartment. (See section 1.2 on installing the battery.)
4. Press the power button for at least 2 seconds to turn on your device.



2.2 Troubleshooting

Power Problems

Power does not turn on when using battery power

- The remaining battery power may be too low to run your device. Connect the AC adapter to your device and then to AC power. Then, turn on your device.

Screen Problems

Screen is off

If the screen does not respond even after you press the power button, try the following steps in this order until the problem is solved:

- Connect the AC adapter to your device and to external AC power.
- Reset your system. (See Section 2.1 for information.)

Screen responds slowly

- Make sure that your device is not running out of battery power. If the problem still exists, reset your system.

Screen freezes

- Reset your system. (See Section 2.1 for information.)

Screen is hard to read

- Make sure that the backlight of the display is on and if necessary adjust the brightness.

GPS Problems

When there are no valid GPS signals available, consider the following:

- Make sure that the device has an unobstructed view of the sky.
- Note that the GPS reception can be affected by:

- ✓ Bad weather
- ✓ Dense overhead obstacles (e.g. trees and tall buildings)
- ✓ Other wireless device in the vehicle
- ✓ Reflective window tint and heated screens

2.3 Maintaining Your Device

Taking good care of your device will ensure trouble-free operation and reduce the risk of damage to your device.

- Keep your device away from excessive moisture and extreme temperatures.
- Avoid exposing your device to direct sunlight or strong ultraviolet light for extended periods of time.
- Do not place anything on top of your device or drop objects on your device.
- Do not drop your device or subject it to severe shock.
- Do not subject your device to sudden and severe temperature changes. This could cause moisture and condensation build up inside the unit which can damage your device. In the event of moisture or condensation, allow the device to dry out completely before use.
- Avoid touching the Screen Surface with sharp objects as it may scratch. Non-adhesive generic screen protectors designed specifically for use on portable devices with LCD panels may be used to help protect the screen from minor scratches.
- Never clean your device with it powered on. Use a soft, lint-free cloth moistened with water to wipe the screen and the exterior of your device.
- Do not use paper towels to clean the screen as this may scratch it.
- Never attempt to disassemble, repair or make any modifications to your device. Disassembly, modification or any attempt at repair could cause damage to your device and even bodily injury or property damage and will void any warranty.
- **Do not store or carry flammable liquids, gases or explosive materials in the same compartment as your device, its parts or accessories.**

Federal Communication Commission Interference Statement

This equipment has been tested and found to comply with the limits for a Class B digital device, pursuant to Part 15 of the FCC Rules. These limits are designed to provide reasonable protection against harmful interference in a residential installation. This equipment generates, uses and can radiate radio frequency energy and, if not installed and used in accordance with the instructions, may cause harmful interference to radio communications. However, there is no guarantee that interference will not occur in a particular installation. If this equipment does cause harmful interference to radio or television reception, which can be determined by turning the equipment off and on, the user is encouraged to try to correct the interference by one of the following measures:

- Reorient or relocate the receiving antenna.
- Increase the separation between the equipment and receiver.
- Connect the equipment into an outlet on a circuit different from that to which the receiver is connected.
- Consult the dealer or an experienced radio/TV technician for help.

FCC Caution: Any changes or modifications not expressly approved by the party responsible for compliance could void the user's authority to operate this equipment.

This device complies with Part 15 of the FCC Rules. Operation is subject to the following two conditions: (1) This device may not cause harmful interference, and (2) this device must accept any interference received, including interference that may cause undesired operation.

IMPORTANT NOTE:

FCC Radiation Exposure Statement:

This equipment complies with FCC radiation exposure limits set forth for an uncontrolled environment. This equipment should be installed and operated with minimum distance 20cm between the radiator & your body.

This transmitter must not be co-located or operating in conjunction with any other antenna or transmitter.

Industry Canada statement:

This device complies with RSS-210 of the Industry Canada Rules. Operation is subject to the following two conditions:

(1) This device may not cause harmful interference, and (2) this device must accept any interference received, including interference that may cause undesired operation.

IMPORTANT NOTE:

Radiation Exposure Statement:

This equipment complies with IC radiation exposure limits set forth for an uncontrolled environment. This equipment should be installed and operated with minimum distance 20cm between the radiator & your body.